

2026

phormalab  
INFRAREDS

  
JARDISHOP.CH

MADE IN ITALY

Jardishop.ch





## PHORMALAB

Via Garibaldi 67/C, Lumezzane, 25065 · Brescia

T · +39.030.871513 — M · info@phormalab.it

WWW.PHORMALAB.IT

---

# Outdoor Lovers

phormalab  
INFRAREDS

## phormalab

è un'azienda italiana con esperienza ventennale nella produzione di lampade riscaldanti ad infrarossi di design.

Phormalab affonda le sue radici in una zona ricca di tradizione, tra il lago di Garda e il lago d'Iseo. È proprio in provincia di Brescia dove si svolge l'intero ciclo produttivo di ogni riscaldatore, progettato per essere utilizzato all'aperto. La sede si trova nel distretto di Lumezzane, cuore pulsante della produzione metalmeccanica lombarda.

Phormalab nasce dall'esperienza pluriennale di Urbani S.r.l., attiva da oltre 60 anni nel settore della lavorazione dei metalli. Il rispetto per la natura e l'arte della lavorazione dell'alluminio sono i pilastri su cui si fonda l'identità aziendale, un connubio tra tradizione e innovazione che guida l'impresa verso il futuro. Oggi, la famiglia Urbani continua a dirigere la crescita e lo sviluppo dell'azienda, puntando a nuovi traguardi e impegnandosi attivamente per le persone e il territorio.

Sin dai suoi esordi, Phormalab si è affermata come il marchio di punta nel settore dei riscaldatori ad infrarossi, attirando l'attenzione di numerosi hotel e ristoranti di lusso in tutto il mondo, che hanno scelto di offrire il massimo comfort ai propri clienti anche negli spazi esterni. I prodotti Phormalab si distinguono per la loro alta gamma e permettono di riscaldare velocemente ambienti interni ed esterni anche nei mesi più freddi, senza sacrificare l'aspetto estetico.

In Phormalab, l'arte artigianale si esprime in diverse forme, adattandosi a ogni tipo di ambiente e soddisfacendo i gusti degli amanti del design. Dalla creazione della collezione Hotdoor, bestseller disegnato da Antonio Di Chiano, alla collaborazione con il designer Stefano Pasotti per la realizzazione di Aura, ogni prodotto è una fusione di artigianalità, tecnica ed estetica, progettato per offrire soluzioni eleganti e funzionali a una clientela esigente.





## phormalab

is an Italian company with 20 years of experience in the production of designer infrared heating lamps.

Phormalab which has its roots in an area rich in tradition, between Lake Garda and Lake Iseo. It is precisely in the province of Brescia where the entire production cycle of each heater, designed for outdoor use, takes place. The headquarters are located in Lumezzane, the beating heart of Lombardy's metalworking production.

Phormalab was born from the long of experience of Urbani S.r.l., active for over 60 years in the metalworking sector. Respect for nature and the art of aluminum processing are the pillars on which the company identity is based, a combination of tradition and innovation that guides the company towards the future. Today, the Urbani family continues to direct the growth and development of the company, aiming for new goals and actively committing to people and the territory.

Since its inception, Phormalab has established itself as the leading brand in the infrared heater sector, attracting the attention of numerous luxury hotels and restaurants around the world, which have chosen to offer maximum comfort to their customers in outdoor spaces. Phormalab products stand out for their high range and allow you to quickly heat internal and external environments even in the coldest months, without sacrificing aesthetics.

In Phormalab, artisanal art is expressed in different forms, adapting to any type of environment and satisfying the tastes of design lovers. From the creation of the Hotdoor collection, a bestseller designed by Antonio Di Chiano, to the collaboration with the designer Stefano Pasotti for the creation of Aura, each product is a fusion of craftsmanship, technique and aesthetics, designed to offer elegant and functional solutions to a demanding clientele.

## DIMMER HOTDOOR

hotdoor dimmer / hotdoor dimmer / gradateur hotdoor / regulador hotdoor



P. 16

**Novità / News / Neuheiten / Nouveautés / Novedades**

## COPERTURE PER HOTDOOR

hotdoor covers / hotdoor abdeckungen / hotdoor couvertures / cubiertas de hotdoor



P. 55

## HOTDOOR ATTACCO OMBRELLONE SINGOLO E DOPPIO

hotdoor single and double umbrella / hotdoor einzel- und doppelsonnenschirm /  
hotdoor parasol simple et double / hotdoot sombrilla s ngula y doble



P. 56

**Novit  / News / Neuheiten / Nouveaut s / Novedades**

## SGANCIO RAPIDO PER ATTACCO AD OMBRELLONE

quick release for umbrella mounting / Schnellverschluss zur sonnenschirmbefestigung /  
d gagement rapide pour fixation du parasol / desenganche r pido para atache de sombrilla



P. 57



---

phormalab  
INFRARED

---



---

# hotdoor

Dalla ricerca e dalla secolare esperienza nella lavorazione dei metalli, nasce il Progetto Hotdoor, con il quale la tradizione manifatturiera incontra il design.

Il risultato è un riscaldatore a raggi infrarossi, ideale per l'esterno, solido e funzionale e, al tempo stesso, dal design raffinato ed elegante.

From a secular experience in metalworking, arises Hotdoor Project, where the manufacturing tradition meets design. The result is an infrared heater, ideal for outdoor use, solid and functional and, at the same time, with a refined and elegant design.

**da P. 8**

---

# aura

Phormalab presenta AURA, la nostra nuova lampada dal design essenziale e dallo stile urbano, che va a integrare la nostra gamma di prodotti.

Frutto di un accurato lavoro di ricerca, AURA affianca un'estetica all'avanguardia ad un'elevata funzionalità ed innovazione tecnologica, lanciando uno sguardo verso il futuro del settore del riscaldamento ad infrarossi.

Phormalab is proud to present AURA, our newest infrared lamp. Characterised by an essential design and an urban style, it fits perfectly among our selection of products.

Derived from a deep research work, AURA implements modern aesthetics to exceptional functionality and technological innovation, embracing a vision towards the future in the field of infrared heating lamps.

**da P. 40**



phormalab  
INFRA REDS

# hotdoor

MADE IN ITALY

[Jardishop.ch](http://Jardishop.ch)



hotdoor



**DESIGN E QUALITÀ MADE IN ITALY**

design and quality made in Italy / design und qualität made in Italy /  
design et qualite made in Italy / diseño y calidad made in Italy

HOTDOOR [PATENTED] DESIGN BY ANTONIO DI CHIANO

Jardishop.ch

IT

**DESIGN:** Disegnato e prodotto in Italia  
**MATERIALI:** Corpo e supporti in alluminio, base in acciaio galvanizzato  
**TECNOLOGIA:** Infrarossi a onda corta  
**BULBO:** Infrarosso Low Glare garantito 5.000 ore di utilizzo  
**GRADO DI PROTEZIONE:** IP44 (la lampada è utilizzabile anche in spazi esterni e resiste agli spruzzi d'acqua)  
**POTENZE DISPONIBILI:** 1500W, 2000 W dimmerabile  
**ALIMENTAZIONE:** 230 V – 50/60 Hz (disponibile anche 110 V)  
**ENERGIA ASSORBITA:** Oltre il 90% dell'energia assorbita viene emessa sotto forma di raggi infrarossi  
**FASCIO SCALDANTE:** Orientabile  
**SPINA:** EU, UK, US, CH, AUS  
**MODALITA' DI INSTALLAZIONE:** a parete, a soffitto, a ombrellone e piantana  
**COLORI CORPO LAMPADA E ACCESSORI:** Nero, bianco e beige  
**COLORI SCOCCA ANTERIORE:** Nero, bianco, argento, ottone, grigio, beige



EN

**DESIGN:** Designed and manufactured in Italy  
**MATERIALS:** Body and accessories in aluminium, base in galvanized iron  
**TECHNOLOGY:** Short wave infrared  
**BULB:** Infrared low glare with 5.000 hours lifespan  
**PROTECTION LEVEL:** IP44 (the lamp can be used outdoors and assures perfect impermeability against water sprinkling)  
**AVAILABLE POWERS:** 1500W, 2000 W dimmable  
**POWER SUPPLY:** 230 V – 50/60 Hz (110 V also available)  
**ABSORBED ENERGY:** More than 90% of the absorbed energy is radiated as infrared emission  
**HEATING BEAM:** directable  
**PLUG:** EU, UK, US, CH, AUS  
**MOUNTING SOLUTIONS:** wall mounted, ceiling mounted, umbrella mounted, free standing  
**HEATER BODY AND ACCESSORIES COLOURS:** Black, white, beige  
**FRAME COLOURS:** Black, white, silver, brass, grey, beige



DE

**DESIGN:** italienisches Design und hergestellt in Italien  
**MATERIALIEN:** Strahler Körper und Zubehör aus Aluminium, Sockel aus verzinktem Stahl  
**TECHNOLOGIE:** Kurzwellen-Infrarot  
**GLÜHBIRNE:** Infrarot mit geringer Blendung und einer Lebensdauer von 5.000 Stunden  
**SCHUTZART:** IP44 (Strahler nutzbar in Außerräumen und Spritwasser- und Regenfest)  
**VERFÜGBARE LEISTUNGEN:** 1500 W, 2000 W dimmbar  
**STROMZUFUHR:** 230 V – 50/60 Hz (verfügbar 110 V)  
**ABSORBIERTEN ENERGIE:** Über 90% der absorbierten Energie strahlt als Infra-rotstrahlung aus  
**HEIZSTRAHL:** einstellbar  
**STECKER:** EU, UK, USA, CH, AUS  
**MONTAGELÖSUNGEN:** Wandmontage, Deckenmontage, Sonnenschirmmontage, freistehend  
**VERFÜGBARE FARBEN KÖRPER UND BEFESTIGUNGSELEMENTE:** Schwarz, Weiß, Beige  
**VERFÜGBARE FARBEN DES FRONTRAHMENS:** Schwarz, Weiß, Silber, Messing, Grau, Beige



FR

**DESIGN :** Design et production italienne  
**MATÉRIELS :** Corps et supports en aluminium, base en acier galvanisé  
**TECHNOLOGIE :** Infrarouge à ondes courtes  
**AMPOULE :** Infrarouge à faible éblouissement garanti pour 5 000 heures d'utilisation  
**PROTECTION :** IP44 (la lampe peut être utilisée à l'extérieur et est imperméable aux jets d'eau et à la pluie)  
**PUISSANCES DISPONIBLES :** 1500W, 2000 W réglable  
**ALIMENTATION :** 230 V – 50/60 Hz (110 V disponible)  
**ÉNERGIE ABSORBÉE :** Plus que 90% de l'énergie absorbée vient réémise comme radiation infrarouge  
**POUTRE CHAUFFANTE :** Orientable  
**PRISE :** EU, UK, USA, CH, AUS  
**SOLUTIONS D'INSTALLATION :** Appliques, plafonniers, lampadaires  
**COULEURS CORPS DE LAMPE ET ACCESSOIRES :** Noir, blanc et beige  
**COULEURS DU CADRE FRONTAL :** Noir, blanc, argent, laiton, gris, beige



ES

**DISEÑO:** Diseñada y producida en Italia.  
**MATERIALES:** Cuerpo y soportes de aluminio, base de acero galvanizado.  
**TECNOLOGÍA:** Infrarrojos de onda corta  
**BOMBILLA:** Infrarrojo de bajo brillo garantizada por 5000 horas de uso  
**GRADO DE PROTECCIÓN:** IP44 (la lámpara puede ser utilizada al exterior, resistente a las salpicaduras de agua y a la lluvia)  
**POTENCIAS DISPONIBLES:** 1500W, 2000 W regulable  
**ALIMENTACIÓN:** 230 V – 50/60 Hz (110 V también disponible)  
**ENERGÍA ABSORBIDA:** Más del 90% de la energía absorbida es emitida en forma de radiación infrarroja  
**HAZ DE CALEFACCIÓN:** Ajustable  
**ENCHUFE:** UE, UK, EE. UU., CH, AUS  
**SOLUCIONES DE INSTALACIÓN:** Lámpara de pared, de techo, de sombrilla, de pie.  
**COLORES DEL CUERPO DE LA LÁMPARA Y ACCESORIOS:** Negro, blanco y beige  
**COLORES DEL MARCO FRONTAL:** Negro, blanco, plata, latón, gris, beige



hotdoor

# VERSIONI

versions / kompositionen /  
compositions / composiciones

---

## PARETE

wall / wand / murale / pared

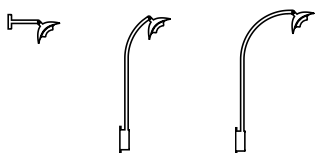

P. 20 – 25

---

## SOFFITTO

ceiling / decke / plafond / techo



P. 26 – 29

---

## PIANTANA

freestanding / stehlampe / lampadaire / lámpara de pie

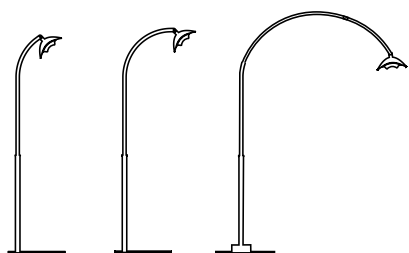

P. 30 – 35

---

## PIANTANA DOPPIA

freestanding double / doppelte stehlampe /  
lampadaire double / lámpara de pie doble

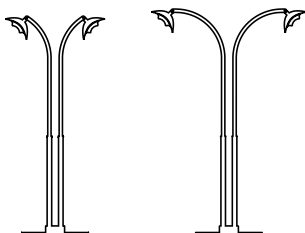

P. 36 – 39

hotdoor

# COLORI

colors / farben /  
couleurs / colores

## COLORI CORPI

bodies / körper / corps / cuerpos



 **NERO**  
black / schwarz / noir / negro

 **BEIGE\***  
beige / beige / beige / beige

 **BIANCO**  
white / weiß / blanc / blanco

## COLORI SCOCICHE

frames / rahmen / cadres / marcos frontales

 **NERO**  
black / schwarz / noir / negro

 **BIANCO**  
white / weiß / blanc / blanco

 **BEIGE\***  
beige / beige / beige / beige

 **GRIGIO\***  
grey / grau / gris / gris

 **ARGENTO\***  
silver / Silber / argent / plata

 **OTTONE\***  
brass / Messing / laiton / bronze



\* Disponibile solo su richiesta / available on request only / nur auf Anfrage erhältlich / disponible uniquement sur demande / disponible sólo bajo petición\*

hotdoor



## DIMMER HOTDOOR

hotdoor dimmer / hotdoor Dimmer /  
gradateur hotdoor / regulador hotdoor

## DIMMER HOTDOOR

hotdoor dimmer / hotdoor dimmer / gradateur hotdoor / regulador hotdoor

Completamente realizzato in alluminio, il dimmer integrato si distingue per la sua robustezza e qualità, mentre il design è perfettamente in sintonia con quello elegante e moderno della lampada. Grazie a questa innovativa funzione, è possibile regolare facilmente l'intensità del calore tramite i pulsanti presenti nella parte posteriore del dispositivo oppure tramite bluetooth, scaricando la app "Phormalab" sul proprio smartphone.

Completely made of aluminum, the integrated dimmer stands out for its sturdiness and quality, while its design is perfectly in harmony with the elegant and modern look of the heater. Thanks to this innovative feature, it is easy to adjust the heat intensity either using the buttons on the back of the device or via Bluetooth by downloading the "Phormalab" app on your smartphone.

## MODELLI COMPATIBILI

available models / kompatible Modelle / modèles compatibles / modelos compatibles

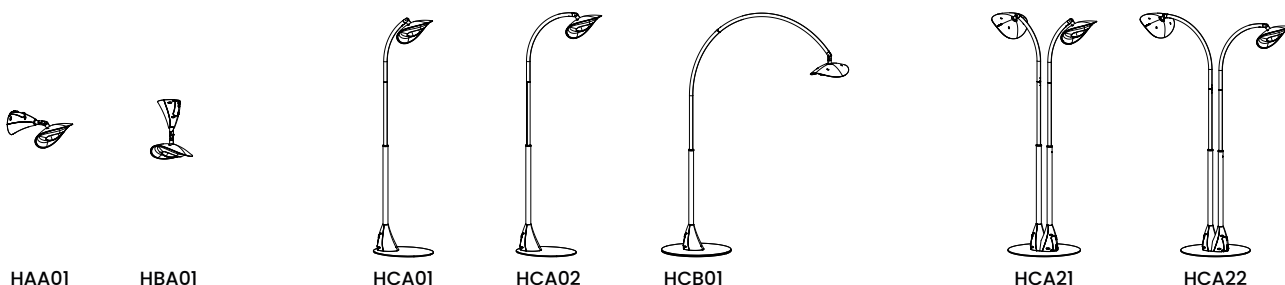

## COLORI DISPONIBILI

Available colours / verfügbare farben / couleurs disponibles / colores disponibles

**NERO**  
black / schwarz / noir / negro

**BEIGE**  
beige / beige / beige / beige

**BIANCO**  
white / weiß / blanc / blanco

## RICEVITORE BLUETOOTH

bluetooth receiver / bluetooth empfangen / bluetooth récepteur / receptor Bluetooth

**3000W** | **POTENZA MAX**  
power / Leistung /  
puissance / potencia

**220V - 230V** | **ALIMENTAZIONE**  
power supply / stromzufuhr /  
alimentation / alimentación

**FROM 0% TO 100%** | **LIVELLI DI FUNZIONE**  
operating levels / laufstufen /  
niveaux de fonction / niveles de función

**- 20° C +50° C** | **TEMPERATURA MIN - MAX**  
temperature min-max / temperatur min-max /  
temperature min-max / temperatura min-max /

**IP44** | **GRADO DI PROTEZIONE**  
degree of protection / schutzstufe /  
degré de protection / grado de protección

**220x185x247** | **DIMENSIONI [mm]**  
sizes [ mm ] / maße [ mm ] /  
dimensions [ mm ] / dimensiones [ mm ]

**PLUG | UE - UK - CH - AUS**













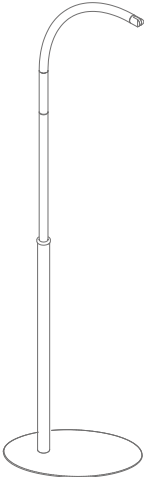

prezzo a pagina / price at page / preis auf seite / precio a página: 55

hotdoor



## ESEMPIO DI COME CREARE IL CODICE

example of how to create your code / Beispiel für die Code-Erstellung / exemple de création de code / ejemplo para la creación del código

MODELLO Model / Modell Modèle / Modelo	COLORE CORPO Body color / Farbe Körper Couleur corp / Color cuerpo	COLORE SCOCCA Frame colour / Farbe des frontrahmens / Couleurs du cadre / Colores del marco	DIMMER Dimmer / Dimmer Gradateur / Regulador	SPINA Plug / Stecker / Prise de courant / Enchufe	POTENZA Power / Leistung Puissance / Potencia
	<b>01</b> BLACK 	<b>01</b> BLACK 	<b>0</b> NO DIMMER	<b>0</b> UE	<b>15</b> 1500 W* 235 V (UE-UK-CH-AUS) 
	<b>02</b> WHITE 	<b>02</b> WHITE 	<b>9</b> DIMMER HOTDOOR* 235 V (UE-UK-CH-AUS) 	<b>1</b> UK	<b>20</b> 2000 W 235 V (UE-UK-CH-AUS)
	<b>06</b> BEIGE** 	<b>03</b> SILVER** 		<b>3</b> CH	
		<b>04</b> BRASS** 		<b>4</b> AUS	
		<b>05</b> GREY** 			
		<b>06</b> BEIGE 			
<b>HCA02</b>	<b>0 1</b>	<b>0 3</b>	<b>9</b>	<b>0</b>	<b>2 0</b>

## ESEMPIO DI COME CALCOLARE IL PREZZO

example of how to calculate the price / Beispiel für die Berechnung des Preises / exemple pour calculer le prix / ejemplo de cómo calcular el precio

### PREZZO

price / prix / preis / precio

Da aggiungere al prezzo base / To add to standard price / Zum Basispreis hinzufügen / Ajouter au prix de base / Añadir al precio base\*

Da aggiungere al prezzo base, disponibile solo su richiesta / To add to standard price, available on request only\*\*

Zum Basispreis hinzufügen, nur auf Anfrage erhältlich / Ajouter au prix de base, disponible uniquement sur demande / Añadir al precio base, disponible sólo bajo petición

### EXTRA:

- COVER SILVER



- DIMMER HOTDOOR



### PREZZO TOTALE:

total price / prix total / gemeinsampreis / precio total

hotdoor



## A PARETE

wall mounted / wandmontiert /  
applique / de pared











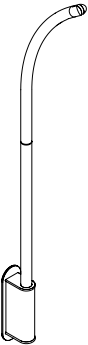

hotdoor

## A PARETE CON ARCO CORTO

wall mounted with short arc / wandmontiert mit kurzem bogen /  
applique avec arc court / de pared con arco corto

# CONFIGURA LA TUA HOTDOOR

Customize your Hotdoor / Konfigurieren Sie Ihre Hotdoor / Configure ton Hotdoor / Configura tu Hotdoor

MODELLO Model / Modell Modèle / Modelo	COLORE CORPO Body color / Farbe Körper Couleur corp / Color cuerpo	COLORE SCOCCA Frame colour / Farbe des frontrahmens / Couleurs du cadre / Colores del marco	DIMMER Dimmer / Dimmer Gradateur / Regulador	SPINA Plug / Stecker / Prise de courant / Enchufe	POTENZA Power / Leistung Puissance / Potencia
 <p><b>HAA11</b></p>	<p><b>01</b> BLACK</p> 	<p><b>01</b> BLACK</p> 	<p><b>0</b> NO DIMMER</p>	<p><b>0</b> UE</p>	<p><b>15</b> 1500 W* 235 V (UE-UK-CH-AUS)</p>
	<p><b>02</b> WHITE</p> 	<p><b>02</b> WHITE</p> 	<p><b>3</b> DIMMER SMART* 235 V (UE-UK-CH-AUS)</p>	<p><b>1</b> UK</p>	<p><b>20</b> 2000 W 235 V (UE-UK-CH-AUS)</p>
	<p><b>06</b> BEIGE**</p> 	<p><b>03</b> SILVER**</p> 	<p><b>3</b> CH</p>	<p><b>3</b> CH</p>	
		<p><b>04</b> BRASS**</p> 	<p><b>4</b> AUS</p>	<p><b>4</b> AUS</p>	
		<p><b>05</b> GREY**</p> 			
		<p><b>06</b> BEIGE</p> 			

## PREZZO

price / prix / preis / precio

Da aggiungere al prezzo base / To add to standard price / Zum Basispreis hinzufügen / Ajouter au prix de base / Añadir al precio base\*

Da aggiungere al prezzo base, disponibile solo su richiesta / To add to standard price, available on request only\*\*

Zum Basispreis hinzufügen, nur auf Anfrage erhältlich / Ajouter au prix de base, disponible uniquement sur demande / Añadir al precio base, disponible sólo bajo petición

## DIMENSIONI [ mm ]

dimensions / abmessungen / dimension / dimensiones

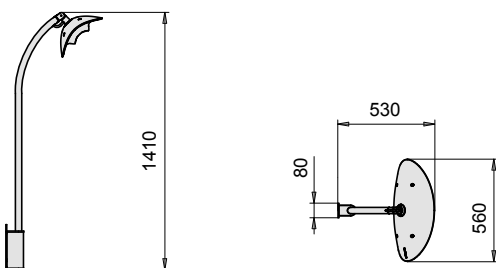

## IMBALLO [ mm ]

packaging / verpackung / emballage / embalaje

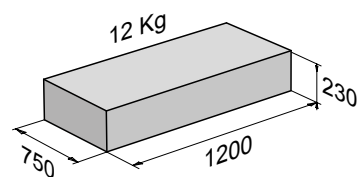

Per la creazione del codice, vedi l'esempio a pagina 19. - To create your code, see example at page 19. - Zur Erstellung des codes siehe Beispiel auf Seite 19. - Pour la création du code, voir l'exemple à la page 19. - Para la creación del código, vea el ejemplo en la página 19.

hotdoor

## A PARETE CON ARCO MEDIO

wall mounted with medium arc / wandmontiert mit mittlerem bogen /  
applique avec arc moyen / de pared con arco medio



hotdoor

# A SOFFITTO

ceiling mounted / deckenmontiert /  
plafonier / de techo











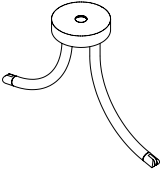

hotdoor

## A SOFFITTO DOPPIA

ceiling mounted double / doppelte deckenmontiert /  
plafonier double / de techo doble

# CONFIGURA LA TUA HOTDOOR

Customize your Hotdoor / Konfigurieren Sie Ihre Hotdoor / Configure ton Hotdoor / Configura tu Hotdoor

MODELLO Model / Modell Modèle / Modelo	COLORE CORPO Body color / Farbe Körper Couleur corp / Color cuerpo	COLORE SCOCCA Frame colour / Farbe des frontrahmens / Couleurs du cadre / Colores del marco	DIMMER Dimmer / Dimmer Gradateur / Regulador	SPINA Plug / Stecker / Prise de courant / Enchufe	POTENZA Power / Leistung Puissance / Potencia
	<b>01</b> BLACK 	<b>01</b> BLACK 	<b>0</b> NO DIMMER	<b>0</b> UE	<b>15</b> 1500 W* 235 V (UE-UK-CH-AUS)
	<b>02</b> WHITE 	<b>02</b> WHITE 	<b>3</b> DIMMER SMART* 235 V (UE-UK-CH-AUS)	<b>1</b> UK	<b>20</b> 2000 W 235 V (UE-UK-CH-AUS)
	<b>06</b> BEIGE** 	<b>03</b> SILVER** 	<b>3</b> CH	<b>3</b> CH	
		<b>04</b> BRASS** 	<b>4</b> AUS	<b>4</b> AUS	
		<b>05</b> GREY** 			
		<b>06</b> BEIGE 			
	<b>HBA21</b>				

## PREZZO

price / prix / preis / precio

Da aggiungere al prezzo base / To add to standard price / Zum Basispreis hinzufügen / Ajouter au prix de base / Añadir al precio base\*

Da aggiungere al prezzo base, disponibile solo su richiesta / To add to standard price, available on request only\*\*

Zum Basispreis hinzufügen, nur auf Anfrage erhältlich / Ajouter au prix de base, disponible uniquement sur demande / Añadir al precio base, disponible sólo bajo petición

## DIMENSIONI [ mm ]

dimensions / abmessungen / dimension / dimensiones

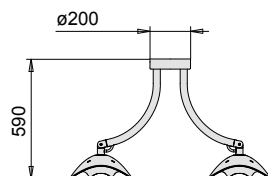
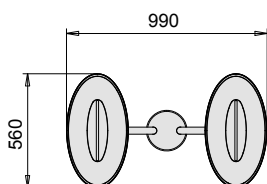

## IMBALLO [ mm ]

packaging / verpackung / emballage / embalaje

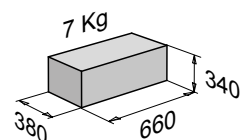
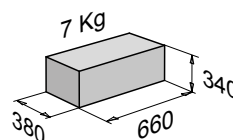

Per la creazione del codice, vedi l'esempio a pagina 19. - To create your code, see example at page 19. - Zur Erstellung des codes siehe Beispiel auf Seite 19. - Pour la création du code, voir l'exemple à la page 19. - Para la creación del código, vea el ejemplo en la página 19.









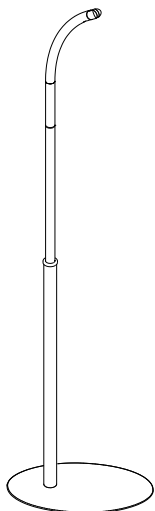

hotdoor

# PIANTANA CON ARCO CORTO

freestanding with short arc / fubodenstnder mit kurzen bogen /  
lampadaire avec arc court / lmpara de pie con con arco corto

# CONFIGURA LA TUA HOTDOOR

Customize your Hotdoor / Konfigurieren Sie Ihre Hotdoor / Configure ton Hotdoor / Configura tu Hotdoor

MODELLO Model / Modell Modèle / Modelo	COLORE CORPO Body color / Farbe Körper Couleur corp / Color cuerpo	COLORE SCOCCA Frame colour / Farbe des frontrahmens / Coleurs du cadre / Colores del marco	DIMMER Dimmer / Dimmer Gradateur / Regulador	SPINA Plug / Stecker / Prise de courant / Enchufe	POTENZA Power / Leistung Puissance / Potencia
	<b>01</b> BLACK 	<b>01</b> BLACK 	<b>0</b> NO DIMMER	<b>0</b> UE	<b>15</b> 1500 W* 235 V (UE-UK-CH-AUS)
	<b>02</b> WHITE 	<b>02</b> WHITE 	<b>9</b> DIMMER HOTDOOR* 235 V (UE-UK-CH-AUS)	<b>1</b> UK	<b>20</b> 2000 W 235 V (UE-UK-CH-AUS)
	<b>06</b> BEIGE** 	<b>03</b> SILVER** 	<b>3</b> CH		
		<b>04</b> BRASS** 	<b>4</b> AUS		
		<b>05</b> GREY** 			
		<b>06</b> BEIGE 			
<b>HCA01</b>	_____	_____	_____	_____	_____

## PREZZO

price / prix / preis / precio

Da aggiungere al prezzo base / To add to standard price / Zum Basispreis hinzufügen / Ajouter au prix de base / Añadir al precio base\*

Da aggiungere al prezzo base, disponibile solo su richiesta / To add to standard price, available on request only\*\*

Zum Basispreis hinzufügen, nur auf Anfrage erhältlich / Ajouter au prix de base, disponible uniquement sur demande / Añadir al precio base, disponible sólo bajo petición

## DIMENSIONI [ mm ]

dimensions / abmessungen / dimension / dimensiones

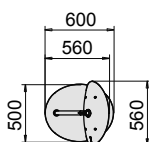
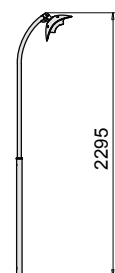

## IMBALLO [ mm ]

packaging / verpackung / emballage / embalaje

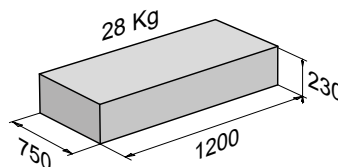

Per la creazione del codice, vedi l'esempio a pagina 19. - To create your code, see example at page 19. - Zur Erstellung des codes siehe Beispiel auf Seite 19. - Pour la création du code, voir l'exemple à la page 19. - Para la creación del código, vea el ejemplo en la página 19.









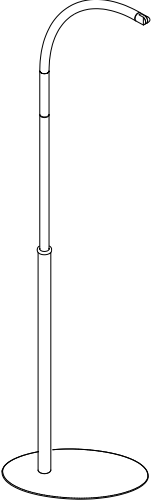

hotdoor

## PIANTANA CON ARCO MEDIO

freestanding with medium arc / fubodenstnder mit mittlerem bogen /  
lampadaire avec arc moyen / lmpara de pie con arco medio

# CONFIGURA LA TUA HOTDOOR

Customize your Hotdoor / Konfigurieren Sie Ihre Hotdoor / Configure ton Hotdoor / Configura tu Hotdoor

MODELLO Model / Modell Modèle / Modelo	COLORE CORPO Body color / Farbe Körper Couleur corp / Color cuerpo	COLORE SCOCCA Frame colour / Farbe des frontrahmens / Coleurs du cadre / Colores del marco	DIMMER Dimmer / Dimmer Gradateur / Regulador	SPINA Plug / Stecker / Prise de courant / Enchufe	POTENZA Power / Leistung Puissance / Potencia
 <p><b>HCA02</b></p>	<p><b>01</b> BLACK</p> 	<p><b>01</b> BLACK</p> 	<p><b>0</b> NO DIMMER</p>	<p><b>0</b> UE</p>	<p><b>15</b> 1500 W* 235 V (UE-UK-CH-AUS)</p>
	<p><b>02</b> WHITE</p> 	<p><b>02</b> WHITE</p> 	<p><b>9</b> DIMMER HOTDOOR* 235 V (UE-UK-CH-AUS)</p>	<p><b>1</b> UK</p>	<p><b>20</b> 2000 W 235 V (UE-UK-CH-AUS)</p>
	<p><b>06</b> BEIGE**</p> 	<p><b>03</b> SILVER**</p> 	<p><b>3</b> CH</p>		
		<p><b>04</b> BRASS**</p> 	<p><b>4</b> AUS</p>		
		<p><b>05</b> GREY**</p> 			
		<p><b>06</b> BEIGE</p> 			

## PREZZO

price / prix / preis / precio

Da aggiungere al prezzo base / To add to standard price / Zum Basispreis hinzufügen / Ajouter au prix de base / Añadir al precio base\*

Da aggiungere al prezzo base, disponibile solo su richiesta / To add to standard price, available on request only\*\*

Zum Basispreis hinzufügen, nur auf Anfrage erhältlich / Ajouter au prix de base, disponible uniquement sur demande / Añadir al precio base, disponible sólo bajo petición

## DIMENSIONI [ mm ]

dimensions / abmessungen / dimension / dimensiones

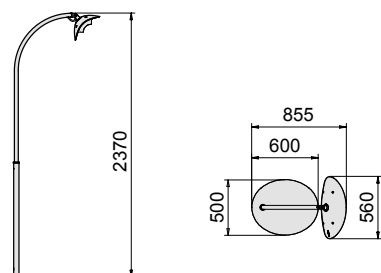

## IMBALLO [ mm ]

packaging / verpackung / emballage / embalaje

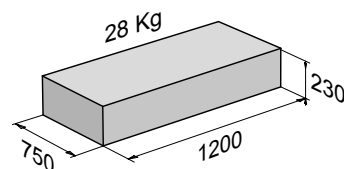

Per la creazione del codice, vedi l'esempio a pagina 19. - To create your code, see example at page 19. - Zur Erstellung des codes siehe Beispiel auf Seite 19. - Pour la création du code, voir l'exemple à la page 19. - Para la creación del código, vea el ejemplo en la página 19.

hotdoor

# PIANTANA DA TAVOLO

freestanding table lamp / fußbodenständer für tisch /  
lampadaire pour le table / lámpara de pie para la mesa











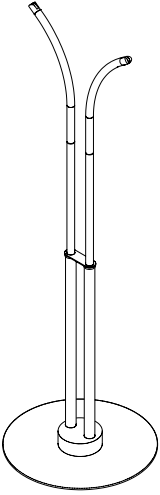

hotdoor

# PIANTANA DOPPIA CON ARCO CORTO

freestanding double with short arc / doppelfußbodenständer mit kurzen bogen /  
lampadaire double avec arc court / lámpara de pie doble con arco corto

# CONFIGURA LA TUA HOTDOOR

Customize your Hotdoor / Konfigurieren Sie Ihre Hotdoor / Configure ton Hotdoor / Configura tu Hotdoor

MODELLO Model / Modell Modèle / Modelo	COLORE CORPO Body color / Farbe Körper Couleur corp / Color cuerpo	COLORE SCOCCA Frame colour / Farbe des frontrahmens / Coleurs du cadre / Colores del marco	DIMMER Dimmer / Dimmer Gradateur / Regulador	SPINA Plug / Stecker / Prise de courant / Enchufe	POTENZA Power / Leistung Puissance / Potencia
 <p><b>HCA21</b></p>	<p><b>01</b> BLACK</p> 	<p><b>01</b> BLACK</p> 	<p><b>0</b> NO DIMMER</p>	<p><b>0</b> UE</p>	<p><b>15</b> 1500 W* 235 V (UE-UK-CH-AUS)</p>
	<p><b>02</b> WHITE</p> 	<p><b>02</b> WHITE</p> 	<p><b>9</b> DIMMER HOTDOOR* 235 V (UE-UK-CH-AUS)</p>	<p><b>1</b> UK</p>	<p><b>20</b> 2000 W 235 V (UE-UK-CH-AUS)</p>
	<p><b>06</b> BEIGE**</p> 	<p><b>03</b> SILVER**</p> 		<p><b>3</b> CH</p>	
		<p><b>04</b> BRASS**</p> 		<p><b>4</b> AUS</p>	
		<p><b>05</b> GREY**</p> 			
		<p><b>06</b> BEIGE</p> 			

## PREZZO

price / prix / preis / precio

Da aggiungere al prezzo base / To add to standard price / Zum Basispreis hinzufügen / Ajouter au prix de base / Añadir al precio base\*

Da aggiungere al prezzo base, disponibile solo su richiesta / To add to standard price, available on request only\*\*

Zum Basispreis hinzufügen, nur auf Anfrage erhältlich / Ajouter au prix de base, disponible uniquement sur demande / Añadir al precio base, disponible sólo bajo petición

## DIMENSIONI [ mm ]

dimensions / abmessungen / dimension / dimensiones

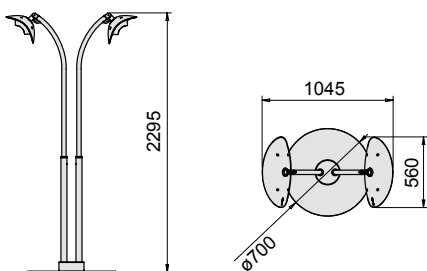

## IMBALLO [ mm ]

packaging / verpackung / emballage / embalaje

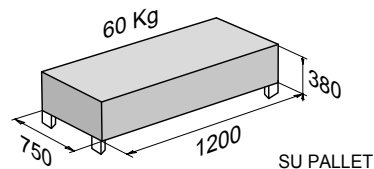

Per la creazione del codice, vedi l'esempio a pagina 19. - To create your code, see example at page 19. - Zur Erstellung des codes siehe Beispiel auf Seite 19. - Pour la création du code, voir l'exemple à la page 19. - Para la creación del código, vea el ejemplo en la página 19.

hotdoor











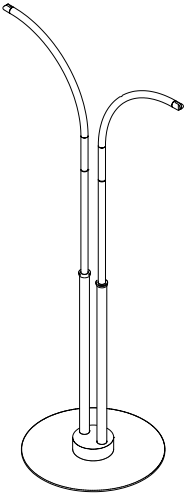
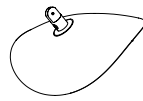
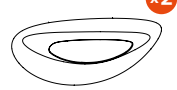

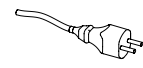
## PIANTANA DOPPIA CON ARCO MEDIO

freestanding double with medium arc / doppelfußbodenständer mit mittleren bogen /  
lampadaire double avec arc moyen / lámpara de pie doble con arco medio



# CONFIGURA LA TUA HOTDOOR

Customize your Hotdoor / Konfigurieren Sie Ihre Hotdoor / Configure ton Hotdoor / Configura tu Hotdoor

MODELLO Model / Modell Modèle / Modelo	COLORE CORPO Body color / Farbe Körper Couleur corp / Color cuerpo	COLORE SCOCCA Frame colour / Farbe des frontrahmens / Couleurs du cadre / Colores del marco	DIMMER Dimmer / Dimmer Gradateur / Regulador	SPINA Plug / Stecker / Prise de courant / Enchufe	POTENZA Power / Leistung Puissance / Potencia
 <p><b>HCA22</b></p>					
	<p><b>01</b> BLACK</p> 	<p><b>01</b> BLACK</p> 	<p><b>0</b> NO DIMMER</p>	<p><b>0</b> UE</p>	<p><b>15</b> 1500 W* 235 V (UE-UK-CH-AUS)</p>
	<p><b>02</b> WHITE</p> 	<p><b>02</b> WHITE</p> 	<p><b>9</b> DIMMER HOTDOOR* 235 V (UE-UK-CH-AUS)</p>	<p><b>1</b> UK</p>	<p><b>20</b> 2000 W 235 V (UE-UK-CH-AUS)</p>
	<p><b>06</b> BEIGE**</p> 	<p><b>03</b> SILVER**</p> 	<p><b>3</b> CH</p>		
		<p><b>04</b> BRASS**</p> 	<p><b>4</b> AUS</p>		
		<p><b>05</b> GREY**</p> 			
		<p><b>06</b> BEIGE</p> 			

## PREZZO

price / prix / preis / precio

Da aggiungere al prezzo base / To add to standard price / Zum Basispreis hinzufügen / Ajouter au prix de base / Añadir al precio base\*

Da aggiungere al prezzo base, disponibile solo su richiesta / To add to standard price, available on request only\*\*

Zum Basispreis hinzufügen, nur auf Anfrage erhältlich / Ajouter au prix de base, disponible uniquement sur demande / Añadir al precio base, disponible sólo bajo petición

## DIMENSIONI [ mm ]

dimensions / abmessungen / dimension / dimensiones

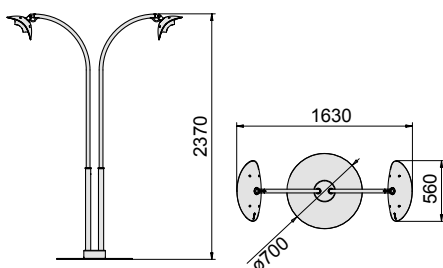

## IMBALLO [ mm ]

packaging / verpackung / emballage / embalaje

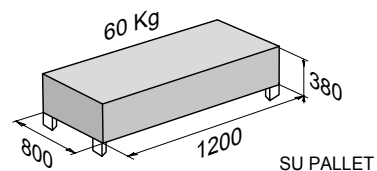

Per la creazione del codice, vedi l'esempio a pagina 19. - To create your code, see example at page 19. - Zur Erstellung des codes siehe Beispiel auf Seite 19. - Pour la création du code, voir l'exemple à la page 19. - Para la creación del código, vea el ejemplo en la página 19.



phormalab  
INFRAREDS

aura

MADE IN ITALY

[Jardishop.ch](http://Jardishop.ch)

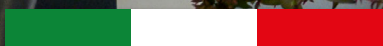

aura



**DESIGN E QUALITÀ MADE IN ITALY**

design and quality made in Italy / design und qualität made in Italy /  
design et qualite made in Italy / diseño y calidad made in Italy

aura DESIGN BY STEFANO PASOTTI

Jardishop.ch

IT

**DESIGN:** Disegnato e prodotto in Italia  
**MATERIALI:** Corpo e supporti in alluminio  
**TECNOLOGIA:** Infrarosso ad onda corta  
**BULBO:** Infrarosso garantito 5.000 ore di utilizzo  
**GRADO DI PROTEZIONE:** IP44 (la lampada è utilizzabile anche in spazi esterni e resiste agli spruzzi d'acqua)  
**POTENZE DISPONIBILI:** 1500W, 2000 W dimmerabile  
**ALIMENTAZIONE:** 230 V – 50/60 Hz (disponibile anche 110 V)  
**ENERGIA ASSORBITA:** Oltre il 90% dell'energia assorbita viene emessa sottoforma di raggi infrarossi  
**FASCIO SCALDANTE:** Orientabile  
**SPINA:** EU, UK, CH, US, AU  
**MODALITA' DI INSTALLAZIONE:** A parete, a soffitto a ombrellone  
**COLORI CORPO LAMPADA E ACCESSORI:** Nero o argento



EN

**DESIGN:** Designed and manufactured in Italy  
**MATERIALS:** Body and accessories in aluminium  
**TECHNOLOGY:** Short wave infrared  
**BULB:** Infrared with 5.000 hours lifespan  
**PROTECTION LEVEL:** IP44 (the lamp can be used outdoors and assures perfect impermeability against water sprinkling)  
**AVAILABLE POWERS:** 1500W, 2000 W dimmable  
**POWER SUPPLY:** 230 V – 50/60 Hz (110 V also available)  
**ABSORBED ENERGY:** More than 90% of the absorbed energy is radiated as infrared emission  
**HEATING BEAM:** Directable  
**PLUG:** EU, UK, US, CH, AUS  
**MOUNTING SOLUTIONS:** Wall mounted, ceiling mounted, umbrella mounted  
**COLORS HEATER BODY AND ACCESSORIES:** Black, silver



DE

**DESIGN:** italienisches Design und hergestellt in Italien  
**MATERIALIEN:** Strahler Körper und Zubehör aus Aluminium  
**TECHNOLOGIE:** Kurzwellen-Infrarot  
**GLÜHBIRNE:** Infrarot mit einer Lebensdauer von 5.000 Stunden  
**SCHUTZART:** IP44 (Strahler nutzbar in Außerräumen und Spritzwasser- und Regenfest)  
**VERFÜGBARE LEISTUNGEN:** 1500 W, 2000 W dimmbar  
**STROMZUFUHR:** 230 V – 50/60 Hz (verfügbar 110 V)  
**ABSORBIERTEN ENERGIE:** Über 90% der absorbierten Energie strahlt als Infra-rotstrahlung aus  
**HEIZSTRAHL:** Einstellbar  
**STECKER:** EU, UK, USA, CH, AUS  
**MONTAGELÖSUNGEN:** Wandmontage, Deckenmontage, Sonnenschirmmontage  
**VERFÜGBARE FARBEN KÖRPER UND BEFESTIGUNGSELEMENTE:** Schwarz, Silber



FR

**DESIGN :** Design et production italienne  
**MATÉRIELS :** Corps et supports en aluminium  
**TECHNOLOGIE :** Infrarouge à ondes courtes  
**AMPOULE :** Infrarouge garanti pour 5 000 heures d'utilisation  
**PROTECTION :** IP44 (la lampe peut être utilisée à l'extérieur et est imperméable aux jets d'eau et à la pluie)  
**PUISSANCES DISPONIBLES :** 1500W, 2000 W réglable  
**ALIMENTATION :** 230 V – 50/60 Hz (110 V disponible)  
**ÉNERGIE ABSORBÉE :** Plus que 90% de l'énergie absorbée vient réémise comme radiation infrarouge  
**POUTRE CHAUFFANTE :** Orientable  
**PRISE :** EU, UK, USA, CH, AUS  
**SOLUTIONS D'INSTALLATION :** Appliques, plafonniers, lampadaires  
**COULEURS CORPS DE LAMPE ET ACCESSOIRES :** Noir, argent



ES

**DISEÑO:** Diseñada y producida en Italia.  
**MATERIALES:** Cuerpo y soportes de aluminio  
**TECNOLOGÍA:** Infrarrojos de onda corta  
**BOMBILLA:** Infrarroja garantizada por 5000 horas de uso  
**GRADO DE PROTECCIÓN:** IP44 (la lámpara puede ser utilizada al exterior, resistente a las salpicaduras de agua y a la lluvia)  
**POTENCIAS DISPONIBLES:** 1500W, 2000 W regulable  
**ALIMENTACIÓN:** 230 V – 50/60 Hz (110 V también disponible)  
**ENERGÍA ABSORBIDA:** Más del 90% de la energía absorbida es emitida en forma de radiación infrarroja  
**HAZ DE CALEFACCIÓN:** Orientable  
**ENCHUFE:** UE, UK, EE. UU., CH, AUS  
**SOLUCIONES DE INSTALACIÓN:** Lámpara de pared, de techo, de sombrilla  
**COLORS DEL CUERPO DE LA LÁMPARA Y ACCESORIOS:** Negro, plata



# aura



## VERSIONI

versions / kompositionen /  
compositions / composiciones

## PARETE

wall / wand / murale / pared

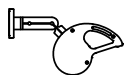

P. 48 – 49

## SOFFITTO

ceiling / decke / plafond / techo

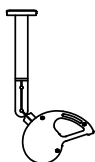

P. 48 – 49

## OMBRELLONE

umbrella / sommenschirm / parasol / sombrilla

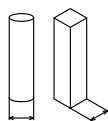
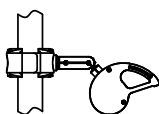

min. Ø35-max. Ø100



cinturino realizzato  
in collaborazione con  
**CHIARUGI**  
HANDMADE IN FLORENCE  
1989

P. 50 – 51

## OMBRELLONE DOPPIO

duble umbrella / doppelsommenschirm /  
parasol double / sombrilla doble

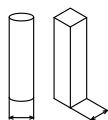
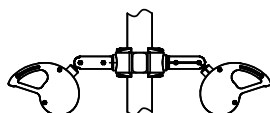

min. Ø35-max. Ø100



cinturino realizzato  
in collaborazione con  
**CHIARUGI**  
HANDMADE IN FLORENCE  
1989

P. 52 – 53



aura

# COLORI

colors / farben /  
couleurs / colores

## AURA BASIC

MONTAGGIO: PARETE-SOFFITTO

Mounting: wall-ceiling / Befestigung: Wand-Decke

Montage: paroi-plafond / Montaje: pared/techo

POTENZA: **1500W, 2000W**

Power / Leistung / Puissance / Potencia

COLORE: NERO

Colour: black / Farbe: schwarz

Couleur: noir / Color: negro



■ **NERO**

black / schwarz / noir / negro

## AURA SMART

TELECOMANDO

Remote control / Fernbedienung

Télécommande / Telemando

ios/Android App

TIMER

Timer / Zeitgeber / Minuterie / Temporizador

DIMMER

Dimmer / Dimmer / Gradateur / Regulador

MONTAGGIO: PARETE-SOFFITTO

Mounting: wall-ceiling / Befestigung: Wand-Decke

Montage: paroi-plafond / Montaje: pared/techo

POTENZA: **1500W, 2000W**

Power / Leistung / Puissance / Potencia

COLORE: NERO - ARGENTO

Colours: black-silver / Farbe: schwarz-Silber

Couleurs: noir-argent / Colores: negro-plata



■ **NERO**

black / schwarz / noir / negro

■ **ARGENTO**

silver / Silber / argent / plata

WATER PROOF  
IP44



SMARTPHONE [IOS/ANDROID]  
REMOTE CONTROL





aura



# A PARETE-SOFFITTO BASIC/SMART

wall-ceiling / wand-decke/  
murale-plafonnier / pared-techo

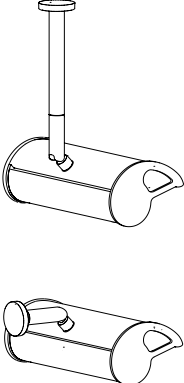

# CONFIGURA LA TUA AURA

Customize your Aura / Konfigurieren Sie Ihre Aura / Configure ton Aura / Configura tu Aura

MODELLO Model / Modell Modèle / Modelo	COLORE CORPO Body color / Farbe Körper Couleur corp / Color cuerpo		DIMMER Dimmer / Dimmer Gradateur / Regulador	SPINA Plug / Stecker / Prise de courant / Enchufe	POTENZA Power / Leistung Puissance / Potencia
	<b>01</b> BLACK 	<b>00</b>	<b>0</b> NO DIMMER	<b>0</b> UE	<b>15</b> 1500 W* 235 V (UE-UK-CH-AUS)
	<b>03</b> SILVER** 		<b>1</b> DIMMER AURA* 235 V (UE-UK-CH-AUS)	<b>1</b> UK	<b>20</b> 2000 W 235 V (UE-UK-CH-AUS)
<b>AAA01</b>	___		___	___	___

## PREZZO

price / prix / preis / precio

Da aggiungere al prezzo base / To add to standard price / Zum Basispreis hinzufügen / Ajouter au prix de base / Añadir al precio base\*  
Solo con DIMMER SMART / Only with DIMMER SMART / Nur mit DIMMER SMART / Seul avec DIMMER SMART / Sólo con DIMMER SMART \*\*

## DIMENSIONI [ mm ]

dimensions / abmessungen / dimension / dimensiones

## IMBALLO [ mm ]

packaging / verpackung / emballage / embalaje

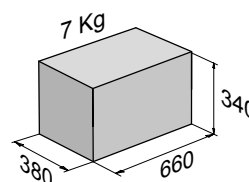
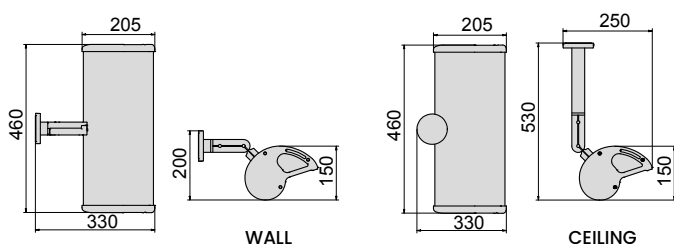

Per la creazione del codice, vedi l'esempio a pagina 19. - To create your code, see example at page 19. - Zur Erstellung des codes siehe Beispiel auf Seite 19. - Pour la création du code, voir l'exemple à la page 19. - Para la creación del código, vea el ejemplo en la página 19.



aura



# OMBRELLONE BASIC/SMART

umbrella / sonnenschirm  
parasol / sombrilla



aura







# OMBRELLONE DOPPIO BASIC/SMART

duble umbrella / doppelsonnenschirm  
parasol double / sombrilla doble

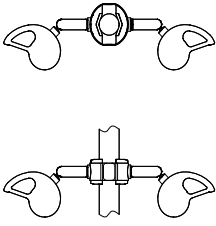
# CONFIGURA LA TUA AURA

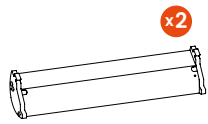
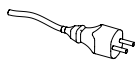
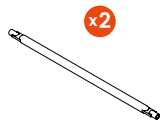
Customize your Aura / Konfigurieren Sie Ihre Aura / Configure ton Aura / Configura tu Aura

MODELLO Model / Modell Modèle / Modelo	COLORE CORPO Body color / Farbe Körper Couleur corp / Color cuerpo	DIMMER Dimmer / Dimmer Gradateur / Regulador	SPINA Plug / Stecker / Prise de courant / Enchufe	POTENZA Power / Leistung Puissance / Potencia
				
	<b>01</b> BLACK 	<b>0</b> NO DIMMER	<b>0</b> UE	<b>15</b> 1500 W* 235 V (UE-UK-CH-AUS)
	<b>03</b> SILVER** 	<b>1</b> DIMMER AURA* 235 V (UE-UK-CH-AUS)	<b>1</b> UK	<b>20</b> 2000 W 235 V (UE-UK-CH-AUS)
			<b>3</b> CH	
			<b>4</b> AUS	
<b>ADA21</b>	___	<b>00</b>	___	___

## PREZZO

price / prix / preis / precio

Da aggiungere al prezzo base / To add to standard price / Zum Basispreis hinzufügen / Ajouter au prix de base / Añadir al precio base\*  
Solo con DIMMER SMART / Only with DIMMER SMART / Nur mit DIMMER SMART / Seul avec DIMMER SMART / Sólo con DIMMER SMART \*\*

## DIMENSIONI [ mm ]

dimensions / abmessungen / dimension / dimensiones

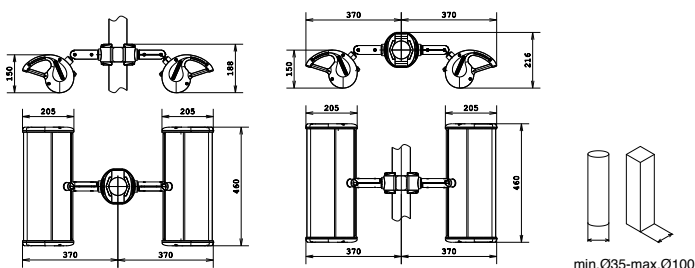

## IMBALLO [ mm ]

packaging / verpackung / emballage / embalaje

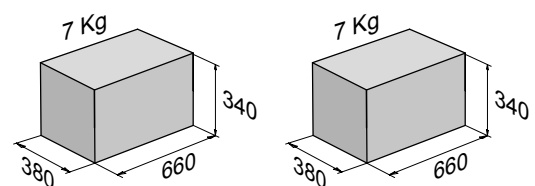

Per la creazione del codice, vedi l'esempio a pagina 19. - To create your code, see example at page 19. - Zur Erstellung des codes siehe Beispiel auf Seite 19. - Pour la création du code, voir l'exemple à la page 19. - Para la creación del código, vea el ejemplo en la página 19.

phormalab  
INFRAREDS

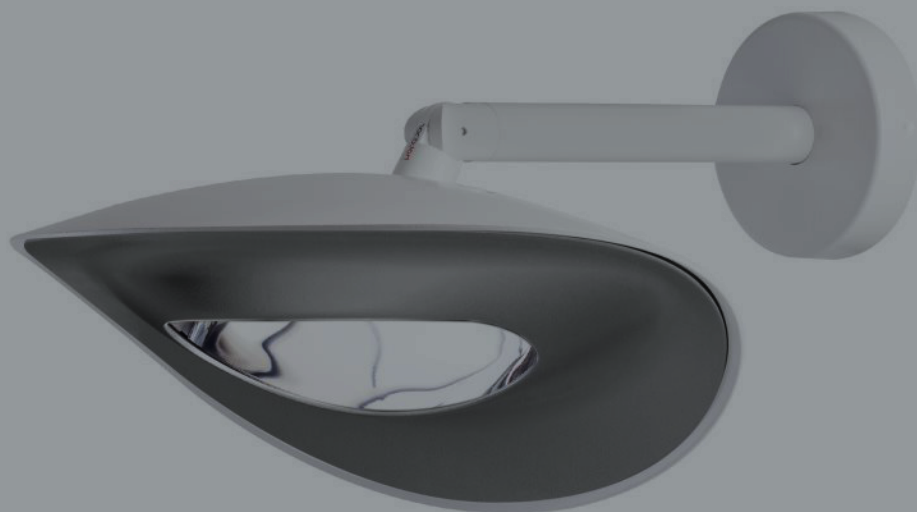

# NOVITÀ, ACCESSORI E RICAMBI

news, accessories and spare parts / neuheiten, zubehöre und ersatzteile /  
nouveautés, accessoires et pièces de rechange / novedades, accesorios y recambios

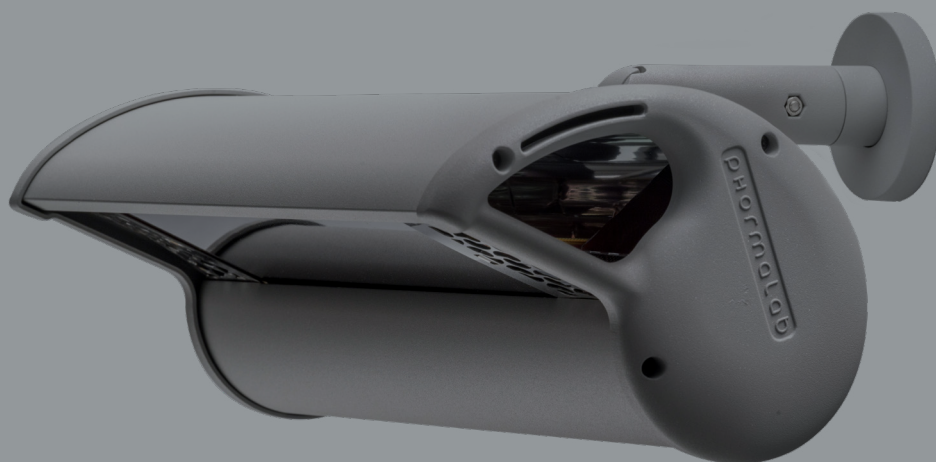

# NOVITÀ

News / neuheiten / nouveautés / novedades

## COPERTURE PER HOTDOOR

hotdoor covers / hotdoor abdeckungen / hotdoor couvertures / cubiertas de hotdoor

Phormalab è lieta di presentare le nuove cover per Hotdoor. Realizzate in tessuto tecnico completamente ignifugo, queste cover sono ideali per proteggere le lampade quando non vengono utilizzate. Offrono una protezione ottimale contro la polvere, prevengono graffi, mantenendo quindi la lampada in perfette condizioni durante il trasporto e lo stoccaggio. Un accessorio pratico e funzionale per preservare nel tempo tua lampada Hotdoor.

Phormalab is pleased to introduce the new covers for Hotdoor. Made from fully fireproof technical fabric, these covers are perfect for protecting the lamps when not in use. They provide optimal protection against dust and prevent scratches, keeping the lamp in perfect condition during transport and storage. A practical and functional accessory to ensure the longevity of your Hotdoor lamp.



Copertura testa / head cover / lampenkopfabdeckung / couverture du tête/ cubierta de cabeza	<b>COPHOT01</b>	
Copertura tubo / pole cover / stangenabdeckung / couverture du pôle / cubierta de poste	<b>COPHOT02</b>	
Copertura base / base cover / basisabdeckung / couverture du base / cubierta de base	<b>COPHOT03</b>	
Copertura modello / cover model / modellabdeckung / couverture du modèle / cubierta modelo	<b>HAA01</b>	
Copertura modelli / cover models / modellabdeckungen / couverture du modèle / cubierta modelos	<b>HAA11-12</b>	
Copertura modello / cover model / modellabdeckung / couverture du modèle / cubierta modelo	<b>HBA01</b>	
Copertura modello / cover model / modellabdeckung / couverture du modèle / cubierta modelo	<b>HBA21</b>	
Copertura modelli / cover models / modellabdeckungen / couverture du modèle / cubierta modelos	<b>HCA01-02</b>	
Copertura modello / cover model / modellabdeckung / couverture du modèle / cubierta modelo	<b>HCB01</b>	
Copertura modelli / cover models / modellabdeckungen / couverture du modèle / cubierta modelos	<b>HCA21-22</b>	

## DIMMER HOTDOOR

hotdoor dimmer / hotdoor dimmer / gradateur hotdoor / regulador hotdoor



Info tecniche p. 17  
Technical information p. 17  
Technische Informationen p. 17  
Informations techniques p. 17  
Informaciones técnicas p. 17

<b>DIM0999B</b>	<b>BLACK</b>	
<b>DIM0999N</b>	<b>WHITE</b>	
<b>DIM0999BE</b>	<b>BEIGE</b>	

# NOVITÀ

News / neuheiten / nouveautés / novedades

## HOTDOOR ATTACCO OMBRELLONE

hotdoor umbrella / hotdoor sonnenschirm / hotdoor parasol / hotdoor sombrilla

A gran richiesta è ora disponibile anche per Hotdoor il pratico attacco per ombrellone, sia nella versione singola che doppia. Questa soluzione già da tempo disponibile per Aura, permette di montare Hotdoor con estrema facilità sui pali di ombrelloni o su pergolati, offrendo una modalità di installazione semplice e sicura.

Abbinando questo accessorio con lo sgancio rapido è possibile rimuovere rapidamente il riscaldatore prima di chiudere l'ombrellone. Inoltre, ogni attacco ad ombrellone è corredato dal cinturino in pelle realizzato in collaborazione con CHIARUGI.

Due to popular demand, the practical umbrella mount is now also available for Hotdoor, both in the single and double versions. Already available for Aura for some time, this solution allows you to mount Hotdoor with ease on umbrella poles or pergolas, offering a simple and secure installation method.

By combining this accessory with the quick release, you can quickly remove the heater before closing the umbrella. Additionally, each umbrella mounting is equipped with a hand-made leather strap made in collaboration with CHIARUGI.

cinturino realizzato  
in collaborazione con  
**CHIARUGI**  
HANDMADE IN FLORENCE  
1989

## HOTDOOR ATTACCO OMBRELLONE SINGOLO

single umbrella / einzelsonnenschirm / parasol simple / sombrilla s ngula

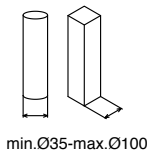

HDA0101000000	BLACK	
HDA0102000000	WHITE	
HDA0106000000	BEIGE	

## HOTDOOR ATTACCO OMBRELLONE DOPPIO

double umbrella / doppelsonnenschirm / parasol double / sombrilla doble

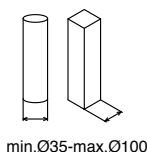

HDA2101000000	BLACK	
HDA2102000000	WHITE	
HDA2106000000	BEIGE	

# NOVITÀ

News / neuheiten / nouveautés / novedades

## SGANCIO RAPIDO PER ATTACCO AD OMBRELLONE

quick release for umbrella mounting / schnellverschluss zur sonnenschirmbefestigung /  
dégagement rapide pour fixation du parasol / desenganche rápido para atache de sombrilla



SP018

## AURA ATTACCO OMBRELLONE SINGOLO

single umbrella / einzelsommenschirm / parasol simple / sombrilla s ngula

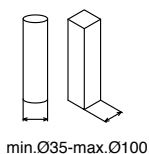

ADA0101000000 **BLACK**

ADA0103000000 **SILVER**

## AURA ATTACCO OMBRELLONE DOPPIO

double umbrella / doppelsommenschirm / parasol double / sombrilla doble

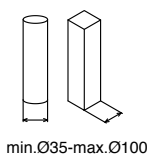

ADA2101000000 **BLACK**

ADA2103000000 **SILVER**

# ACCESSORI E RICAMBI

accessories and spare parts / zubehör und ersatzteile / accessoires et pièces de rechange / accesorios y repuestos

## DIMMER SMART

dimmer / dimmer / gradateur / regulador

- 3000W** | **POTENZA MAX**  
power / Leistung /  
puissance / potencia
- 220V - 230V** | **ALIMENTAZIONE**  
power supply / stromzufuhr /  
alimentation / alimentación
- FROM 0% TO 100%** | **LIVELLI DI FUNZIONE**  
operating levels / laufstufen /  
niveaux de fonction / niveles de función
- 20° C +50° C** | **TEMPERATURA MIN - MAX**  
temperature min-max / temperatur min-max /  
temperature min-max / temperatura min-max /
- IP44** | **GRADO DI PROTEZIONE**  
degree of protection / schutzstufe /  
degré de protection / grado de protección
- 118x115x52** | **DIMENSIONI [mm]**  
sizes [ mm ] / maße [ mm ] /  
dimensions [ mm ] / dimensiones [ mm ]
- PLUG** | **UE - UK - CH - US**



## RICEVITORE INFRAROSSI -TELECOMANDO/BLUETOOTH

infrared-bluetooth receiver  
infrarot-bluetooth empfänger  
infrarouge-bluetooth récepteur sans fil  
receptor inalámbrico infrarrojos bluetooth

<b>DIM03</b>	<b>UE</b>	
<b>DIM04</b>	<b>UK</b>	
<b>DIM05</b>	<b>CH</b>	
<b>DIM06</b>	<b>US</b>	

## DIMMER BASIC

dimmer / dimmer / gradateur / regulador

- 2000W** | **POTENZA MAX**  
power / Leistung /  
puissance / potencia
- 230V** | **ALIMENTAZIONE**  
power supply / stromzufuhr /  
alimentation / alimentación
- FROM 50% TO 100%** | **LIVELLI DI FUNZIONE**  
operating levels / laufstufen /  
niveaux de fonction / niveles de función
- 20° C +50° C** | **TEMPERATURA MIN - MAX**  
temperature min-max / temperatur min-max /  
temperature min-max / temperatura min-max /
- IP54** | **GRADO DI PROTEZIONE**  
degree of protection / schutzstufe /  
degré de protection / grado de protección
- 145x115x55** | **DIMENSIONI [mm]**  
sizes [ mm ] / maße [ mm ] /  
dimensions [ mm ] / dimensiones [ mm ]
- NO PLUG**



## RICEVITORE WIRELESS INFRAROSSI

infrared-wireless receiver  
infrarot-wireless empfänger  
receptor inalámbrico infrarrojos  
infrarouge-sans fil récepteur

<b>DIM01</b>	
--------------	--

## TELECOMANDO

remote control switch / fernbedienung  
télécommande / mando a distancia



<b>TEL01</b>	
--------------	--

## TELECOMANDO MULTIPLO

multiple remote control / Mehrere Fernbedienung  
télécommande multiple / mando a distancia múltiple



<b>TEL04</b>	
--------------	--

## ACCESSORI E RICAMBI

accessories and spare parts / zubehör und ersatzteile / accessoires et pièces de rechange / accesorios y repuestos

### KIT ANTIABBAGLIAMENTO

kit anti-glare / kit blendschutz / kit antéblouissement / kit anti-deslumbramiento



KIT03	
-------	--

### LAMPADINA A RAGGI INFRAROSSI

infrared bulb / infrarot heizelement / ampoule à infrarouge / bombilla infrarrojos



BUL02IMB	1500 W - 230 V	
BUL03IMB	2000W - 230V	
BUL04IMB	1500W - 110V	
BUL05IMB	1500W - 230V LOW GLARE	
BUL06IMB	2000W - 230V LOW GLARE	
BUL07IMB	1500W - 110V	

### PESO EXTRA

extra weight / poids supplémentaire / extra gewicht / peso extra

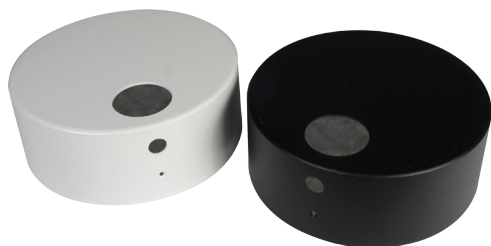

KIT04B	WHITE	
KIT04N	BLACK	
KIT04BE	BEIGE	

### CAVI CON SPINA

plug / stecker / prise de courant / enchufe

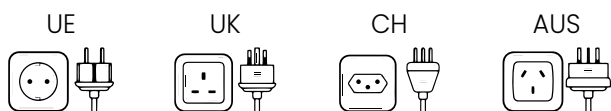

	PLUG	CABLE LENGHT (m)	
SC0110	UE	10	
SC0102	UE	2	
SC0203	UK	2	
SC0303	CH	2	
SC0502	AUS	2	
SC0406	US	2	

## Perché scegliere Phormalab

phormalab



ALIMENTAZIONE	ELETTRICITÀ	BOMBOLA GAS 15KG
SUPERFICIE RISCALDATA	10	10
DURATA	5000h	15h
CONSUMO ORARIO	2kWh	1kg/h
COSTO ORARIO	0,30 €/h	2,60€/h
CONSUMO GIORNALIERO 6h di utilizzo	1,80 €	15,60 €
<b>COSTO MENSILE</b>	<b>36 €</b>	<b>312 €</b>

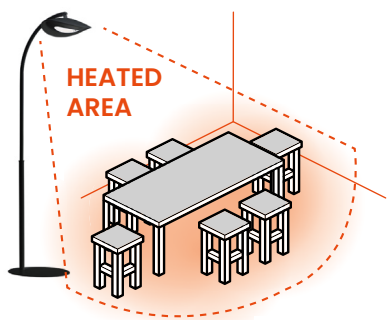

### POWER

**1500W**  
8 - 10 m<sup>2</sup>

**2000W**  
10 - 12 m<sup>2</sup>

## CONFRONTO GAS/INFRAROSSO

Scegli l'efficienza energetica di Phormalab.

Sebbene i riscaldatori a gas sembrano, a prima vista, una scelta ovvia per riscaldare le aree outdoor, un confronto tra i consumi dei riscaldatori a gas e le soluzioni Phormalab evidenzia numerosi vantaggi per quest'ultime:

- Maggiore efficienza, con un utilizzo ottimale dell'energia e un riscaldamento più uniforme dell'area.
- Costi di gestione e consumi notevolmente inferiori.

Considerando l'ipotesi di riscaldare 10 m<sup>2</sup> per sei ore al giorno con entrambe le tecnologie, **con la soluzione Phormalab, abbiamo un risparmio mensile di 276€ per ogni riscaldatore e di quasi 2.000€ in sette mesi.**

"I dati riportati provengono dal sito ufficiale dell'Autorità di Regolazione per Energia Reti e Ambiente (ARERA) <https://www.arera.it>, che regola e monitora i prezzi dell'energia in Italia." I dati indicati fanno riferimento alla media nazionale italiana per il primo quadrimestre del 2025.

## SERVIZIO

Phormalab offre un servizio pre e post-vendita.

Il nostro team tecnico, in collaborazione con il reparto commerciale, offre supporto fin dalle fasi iniziali, suggerendo la disposizione e l'installazione ottimale delle lampade progettando con il committente il layout dello spazio. Dopo l'acquisto, garantiamo un'assistenza continua, disponibile per manutenzione, riparazioni o aggiornamenti, assicurando il massimo rendimento e durata dei prodotti. Con Phormalab, ogni progetto è un'esperienza continua, supportata da un'attenzione costante al cliente.

## DESIGN

Qualità dei materiali e Made in Italy.

La produzione interna garantisce un controllo totale sulla qualità: ogni lampada Phormalab è attentamente monitorata in ogni fase, dalla progettazione alla consegna. Siamo fieri di promuovere una filosofia produttiva che rispetta e valorizza il nostro territorio, creando riscaldatori non solo performanti e duraturi, ma anche eleganti complementi d'arredo che si integrano perfettamente con gli spazi esterni. Il nostro design senza tempo non segue le mode passeggere, ma si distingue per l'uso di materiali di alta qualità, come l'alluminio, che è intrinsecamente sostenibile grazie alla sua capacità di essere riciclato all'infinito.

## CUSTOMIZZAZIONE

Phormalab unisce l'arte artigiana alle più moderne tecniche industriali.

La nostra produzione interna ci consente di creare soluzioni altamente personalizzabili, progettate per rispondere alle specifiche esigenze degli architetti e dei clienti.

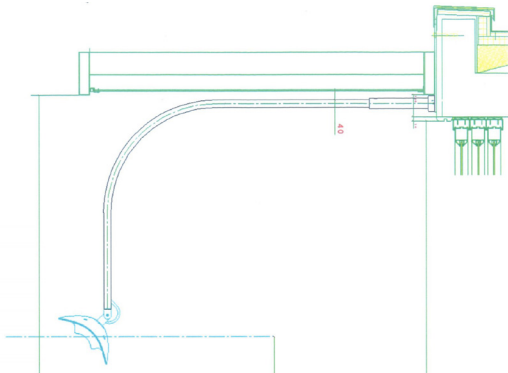

### CASE HISTORY:

In un recente progetto, il cliente ha richiesto di fissare il riscaldatore al frontalino sotto una tettoia. Il nostro team tecnico ha progettato una soluzione innovativa, che ha permesso di posizionare il riscaldatore alla distanza ideale dalle sedute, garantendo così il massimo comfort per i clienti del ristorante.



Un altro esempio di personalizzazione riguarda la richiesta da parte di un Hotel di avere dei pali più lunghi per hotdoor a soffitto. L'obiettivo era riscaldare le sedute senza intralciare l'apertura degli ombrelloni. In questo caso il nostro staff tecnico ha sviluppato dei pali da un metro e un attacco speciale capace di resistere al forte vento presente sulla terrazza.



Su richiesta, lo staff di Phormalab è disponibile a produrre lotti di prodotti di colori personalizzati, anche al di fuori del nostro catalogo standard. Ogni qualvolta si presenta questa richiesta da parte del committente lo staff di Phormalab condivide le possibili soluzioni, i costi e le tempistiche che ne derivano.

## Why choose Phormalab

phormalab



ENERGY	ELECTRICITY	GAS CYLINDER 15KG
HEATED AREA	10	10
LIFE SPAN	5000h	15h
HOURLY CONSUMPTION	2kWh	1kg/h
HOURLY COST	0,30 €/h	2,60€/h
DAILY CONSUMPTION 6h of use	1,80 €	15,60 €
<b>MONTHLY COST</b>	<b>36 €</b>	<b>312 €</b>

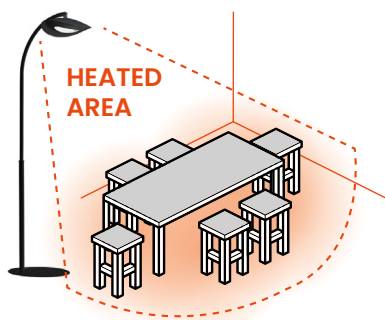

### POWER

**1500W**  
8 - 10 m<sup>2</sup>

**2000W**  
10 - 12 m<sup>2</sup>

## GAS/INFRARED COMPARISON

Choose the energy efficiency of Phormalab.

Although gas heaters seem, at first glance, to be an obvious choice for heating outdoor areas, a comparison between the consumption of gas heaters and Phormalab solutions highlights numerous advantages for the latter:

- ▶ Greater efficiency, with optimal use of energy and more uniform heating of the area.
- ▶ Significantly lower management costs and consumption.

Considering the hypothesis of heating 10 m<sup>2</sup> for six hours a day with both technologies, **with Phormalab we have a monthly saving of €276 for each heater and of almost 2.000€ in seven months.**

"The source of the provided data is the official website of the Regulatory Authority for Energy, Networks, and the Environment (ARERA) <https://www.arera.it>, which regulates and monitors energy prices in Italy." The indicated data refer to the national average for Italy for the first quarter of 2025.

## SERVICE

Phormalab before and after-sales service.

Our technical team, in collaboration with the commercial department, offers support from the initial stages, suggesting the optimal arrangement and installation of the lamps, designing the layout of the space with the client. After purchase, we guarantee continuous assistance, available for maintenance, repairs or updates, ensuring maximum performance and durability of the products. With Phormalab, every project is a continuous experience, supported by constant attention to the customer.

## DESIGN

Quality of materials and Made in Italy.

Internal production guarantees total control over quality: each Phormalab lamp is carefully monitored at every stage, from design to delivery. We are proud to promote a production philosophy that respects and enhances our territory, creating not only high-performance and long-lasting heaters, but also elegant furnishing accessories that integrate perfectly with outdoor spaces. Our timeless design does not follow passing fashions, but is distinguished using high-quality materials, such as aluminum, which is intrinsically sustainable thanks to its ability to be endlessly recycled.

## CUSTOMIZATION

Phormalab combines artisan art with the most modern industrial techniques.

Our internal production allows us to create highly customizable solutions, designed to meet the specific needs of architects and customers.

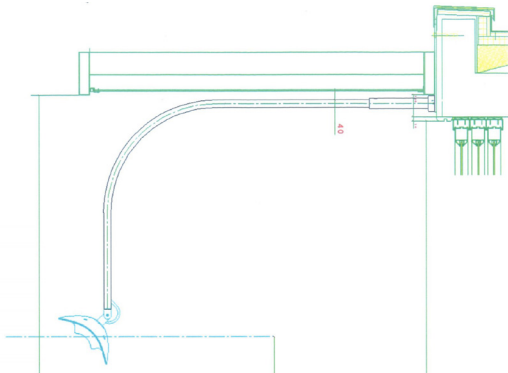

### CASE HISTORY:

On a recent project, the customer requested that the heater be attached to the faceplate under a canopy. Our technical team designed an innovative solution, which allowed the heater to be positioned at the ideal distance from the seats, thus ensuring maximum comfort for restaurant customers.



Another example of customization was the request from a Hotel to have longer poles for hotdoor ceiling mounted. The aim was to heat the tables without standing in the way of the sun umbrellas. In this case our technical staff developed one-meter-long poles and a custom fixing capable to stand against the strong winds of the rooftop.



Upon request, Phormalab staff is available to produce batches of customized colour products, even outside of our standard catalogue. Whenever this request arises from the client, Phormalab's staff shares the possible solutions, costs and leading time.

# CONDIZIONI GENERALI DI VENDITA

general sales conditions / allgemeine verkaufsbedingungen / conditions generales de vente  
condiciones generales de venta

IT

CONDIZIONI GENERALI  
DI VENDITA



**01.** Le presenti condizioni generali di vendita si intendono integralmente accettate dal cliente con il conferimento dell'ordine. **02.** Gli ordini o gli impegni assunti dai nostri rappresentanti sono validi unicamente dopo nostra accettazione o conferma scritta. **03.** I dati, le misure, gli articoli, i prezzi, le caratteristiche, le prestazioni e tutti gli altri dati riprodotti nei nostri cataloghi, listini, prospetti, circolari ecc. hanno carattere indicativo; essi possono essere variati senza alcun preavviso, e hanno valore vincolante per noi unicamente in caso di espressa indicazione nell'accettazione o nella conferma. **04.** Eventuali reclami o contestazioni non daranno in alcun caso diritto al cliente di omettere o ritardare i pagamenti della fornitura. Per essere validi i reclami dovranno pervenirci entro 8 giorni dalla data di ricevimento della merce. **05.** Il cliente non potrà restituire per alcuna ragione materiale senza nostra espressa autorizzazione scritta. In caso di forza maggiore, ci riserviamo la facoltà di sospendere le consegne e anche di annullare ordini debitamente accettati senza che ciò possa dare diritto al cliente di chiedere qualsivoglia indennizzo o risarcimento danni. **06.** Eventuali ritardi nelle consegne non daranno diritto al cliente ad indennizzi e/o risarcimento danni. Le consegne anche se parziali di merce non possono essere rifiutate dal cliente e non danno diritto all'annullamento dell'ordine. **07.** La resa del materiale s'intende effettuata sempre "franco partenza". Ogni nostra responsabilità cessa con la consegna al cliente od al vettore e quindi il materiale viaggia a rischio e pericolo del cliente. Nei casi in cui, per accordi specifici intervenuti con il cliente, il materiale sia venduto "franco destino" non verranno comunque accettate contestazioni per eventuali furti, rotture o manomissioni. Eventuali accordi con spedizionieri, ivi compreso l'ammontare ed il pagamento del prezzo del

trasporto, s'intenderanno sempre conclusi in nome e per conto del cliente che sin d'ora accetta e ratifica il nostro operato. **08.** Tutti i nostri prodotti vengono accuratamente collaudati in stabilimento; essi sono pertanto coperti da garanzia dai difetti di fabbricazione per un periodo di due anni dalla data di emissione della fattura o della ricevuta fiscale emessa dal rivenditore. **09.** La ditta produttrice s'impegna a riparare o sostituire gratuitamente quelle parti che entro il periodo di garanzia, si dimostrassero difettose di fabbricazione. Difetti non chiaramente attribuibili al materiale o alla fabbricazione verranno esaminati presso il nostro centro di assistenza tecnica e addebitati a seconda dell'esito della verifica. Sono comunque esclusi dalla garanzia: i danni accidentali per trasporto, per incuria, per uso ed installazione errati o non conformi alle avvertenze riportate sul libretto di istruzioni. La garanzia decade qualora l'apparecchio sia stato manomesso o riparato da terzi non autorizzati. In questi casi è esclusa la sostituzione dell'apparecchio ed il prolungamento della garanzia a seguito di intervenuto guasto. Le riparazioni vengono eseguite presso il nostro centro di assistenza tecnica autorizzato; la merce da riparare o sostituire in garanzia deve pervenire presso il centro in porto franco, cioè con spese di trasporto a carico del cliente. **10.** Decliniamo ogni responsabilità per eventuali danni a persone, animali o cose derivanti dall'utilizzo degli apparecchi senza osservanza delle prescrizioni di sicurezza o comunque non installati correttamente e/o installati senza effettuare i controlli d'uso. **11.** I prezzi riportati sul listino si intendono al netto di IVA. **12.** Per qualsiasi controversia derivante da nostra vendita, il contratto sarà disciplinato dalla Legge Italiana, e la competenza sarà unicamente del Foro di Brescia.

EN

GENERAL SALES  
CONDITIONS



**01.** These general sales conditions are considered fully accepted by the customer upon confirmation of the order. **02.** The orders and commitments undertaken by our representatives are only valid following our written acceptance or confirmation. **03.** The data, measurements, articles, prices, features, performance and all other data shown in our catalogues, price lists, prospectuses, circulars etc. are given as an indication only; they may be changed without any warning and are only considered binding for us in the event of their explicit mention in the acceptance or confirmation. **04.** Under no circumstances will any complaints or disputes give the customer any right to omit or delay payments for the delivery. In order for them to be valid, complaints must reach us within 8 days of receipt of the goods. **05.** The customer cannot return the material for any reason without our explicit written authorization. In the event of majeure force, we reserve the right to suspend deliveries and even to cancel duly accepted orders without the customer having any right to ask for any type of compensation or damages. **06.** Any delays in deliveries will not give the customer the right to compensation and/or damages. Deliveries of goods, even if partial, cannot be refused by the customer and do not give the customer the right to cancel the order. **07.** The delivery of material is considered ex works. All our responsibility ceases with delivery to the customer or courier and therefore the material is transported at the customer's own risk. In cases in which, due to specific customer interventions, the material is sold delivered to destination, no disputes will be accepted for any thefts, breakages or tampering. Any agreements with forwarding agents, including the amount and payment of the cost of transportation are considered settled in the name of

and on behalf of the customer who from this moment onwards accepts and approves our conduct. **08.** All our products are carefully tested in our factory, and they are therefore warranted against manufacturing defects for a period of two years from the date of issue of our invoice or from the receipt (or other sale document) issued by the dealer. **09.** The manufacturer undertakes to repair or replace free of charge any parts that within the warranty period should show manufacturing defects. Defects not clearly imputable to materials or making, will be examined by our customer service and charged to the customer according to the results of the inspection. Accidental damage due to transport, due to neglect or incorrect installation or use, or not in compliance with the instructions or warnings contained in our installation hand-book are excluded from the guarantee. The warranty fails if our product has been tampered with or repaired by unauthorized people, and the replacement of the product and the extension of guarantee after occurred failure is excluded. Repairs are carried out by our authorized customer service. The goods to be repaired or replaced under warranty must be received by our customer service free of charge including transport. **10.** We refuse all responsibility for any damage or injury to persons, animals or things deriving from the use of the appliances without observing the safety provisions or from appliances which are not installed correctly and/or have been installed without performing user checks. **11.** The prices shown in the price list do not include VAT. **12.** For any controversy deriving from our sale, the contract will be regulated by Italian Law and the Court of Brescia will have sole competence.

DE



**01.** Die vorliegenden allgemeinen Verkaufsbedingungen werden mit der erbrachten Auftragsabgabe von dem Kunden vollständig akzeptiert. **02.** Die durch unsere Vertreter angenommenen Aufträge oder Verpflichtungen sind nur dann gültig, wenn sie von uns schriftlich akzeptiert oder bestätigt wurden. **03.** Die Größen, Artikel, Preise, Eigenschaften, Leistungen und alle anderen Auskünfte aus unseren Katalogen, Preislisten, Prospekten, Rundschreiben usw. sind Richtdaten; sie können ohne Vorankündigung geändert werden und sind für uns nur im Falle eines ausdrücklichen Hinweises bei der Annahme oder Bestätigung verbindlich. **04.** Eventuelle Reklamationen oder Beanstandungen geben dem Kunden nicht das Recht die Zahlung der Lieferungen zu unterlassen oder zu verzögern. Damit die Reklamationen gültig sind, müssen sie 8 Tage nach Erhalt der Ware bei uns eingehen.

**05.** Der Kunde kann ohne unsere ausdrückliche schriftliche Zustimmung auf keinen Fall Material zurückgeben. Im Falle von höherer Gewalt behalten wir uns das Recht vor, Lieferungen einzustellen sowie ordnungsgemäß angenommene Aufträge zu stornieren, ohne, dass dies dem Kunden das Recht gibt Entschädigungen oder Schadensersatz zu fordern. **06.** Eventuelle Verspätungen der Lieferungen geben dem Kunden nicht das Recht, Entschädigungen und/oder Schadensersatz zu fordern. Die Lieferungen, auch nur Teillieferungen, können vom Kunden nicht verweigert werden und geben kein Recht zur Stornierung des Auftrages. **07.** Die Übergabe des Materials ist immer frei ab Werk. Unsere Verantwortung endet mit der Auslieferung an den Kunden oder an das Transportunternehmen, somit gehen Risiko und Gefahr auf den Kunden über. Im Falle, dass aufgrund besonderer Einigungen mit dem Kunden, das Material



## PHORMALAB

Via Garibaldi 67/C, Lumezzane, 25065 · Brescia

T · +39.030.871513 – M · info@phormalab.it

WWW.PHORMALAB.IT

---



CERTIFICATION



CERTIFICATION  
FOR AUSTRALIA  
AND NEW ZEALAND



Chemin du Lazaret 20  
1950 Sion

[www.jardishop.ch](http://www.jardishop.ch)

**Team Jardishop**  
076 306 00 21

[info@jardishop.ch](mailto:info@jardishop.ch)